



深圳名彩智能卡有限公司  
Shenzhen Leadercolor Smart Card Co., Ltd.

 +86 755 89379391 89379456

 +86 755 89379456

 sales@leadercolor.com

 [Http://www.leadercolor.com](http://www.leadercolor.com)

 2F, Building A11, No.6 Xinfeng Road, Taizhong Industrial Zone,  
Longgang District, Shenzhen China 518172

## PRODUCT MANUAL

---

Committed to providing high-performance RFID product for our customers

# COMPANY >>> PROFILE

Shenzhen Leadercolor Smart Card Co.,LTD was established in 2009, is a collection of smart card design, product development, manufacturing and domestic and overseas sales and integration of professional production of a variety of chip cards, plastic card company, the company with high quality and attentive service has won the trust of customers at home and abroad, our products are mainly applied in a variety of large public places such as hotels, hospitals, buses and subways and clubs, and government agencies such as banks, telecommunications, schools and so on. The company has reached long-term strategic cooperation with the world's Formula 1 racing, Western hotel chains, etc.

The company is willing to work with dedicated, expertise and professional partners to create an influential company in the industry that can continuously improve its value. We have a passionate, equal and open team, we have a perfect career development and promotion system, we have a highly competitive salary and welfare system, we have a variety of staff activities, and we can provide a borderless development stage for capable staff! The excellent team of Leadercolor Smart Card will be able to cut through all the difficulties and make great efforts to provide the broadest development stage for every Leadercolor person. We look forward to your joining us...



Customized Size

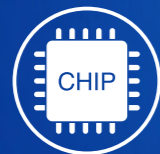

Customized Chip



Customized Material

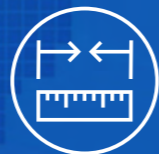

Customized Read Range



Quality



Patent



Small Quantity



Professional Service

# PRODUCT >>> CONTENTS

## RFID ANIMAL EAR TAG

01 UHF Animal Ear Tag	P02
02 LF Animal Ear Tag	P03
03 Conventional Ear Tag	P04
04 UHF RFID Plus LF Animal Ear Tag	P05
05 Animal Ear Tag Applicator + RFID Reader	P06
05 134.2khz RFID Glass Tag with Syringe	P07-08

## RFID TAG

01 UHF RFID Windshield Tag	P10
02 UHF RFID Tag	P11
03 UHF RFID Jewelry Tag	P12
04 UHF RFID Anti-metal Tag	P13-14
05 UHF RFID Clothing Tag	P15-16
06 NFC Sticker	P17-18
07 RFID Library Tag	P19
08 RFID Sports Tag	P20
09 UHF RFID Special Tag	P21
10 Inlay	P22

## RFID WRISTBAND

01 Disposable Wristband	P24
02 Silicone Wristband	P25
03 Nylon Wristband	P26

## RFID SMART CARD

01 NFC Epoxy Tag	P28
02 RFID Keyfob	P29
03 RFID Smart Card	P30

## RFID READER

01 UHF RFID Reader	P32
02 HF RFID Reader	P33
03 LF RFID Reader	P34
04 UHF RFID Antenna	P35
05 UHF RFID Module	P36



## RFID Animal Ear Tag

- 01 UHF Animal Ear Tag
- 02 LF Animal Ear Tag
- 03 Conventional Ear Tag
- 04 UHF RFID Plus LF Animal Ear Tag
- 05 Animal Ear Tag Applicator + RFID Reader
- 06 134.2khz RFID Glass Tag with Syringe

## UHF RFID Animal Ear Tag

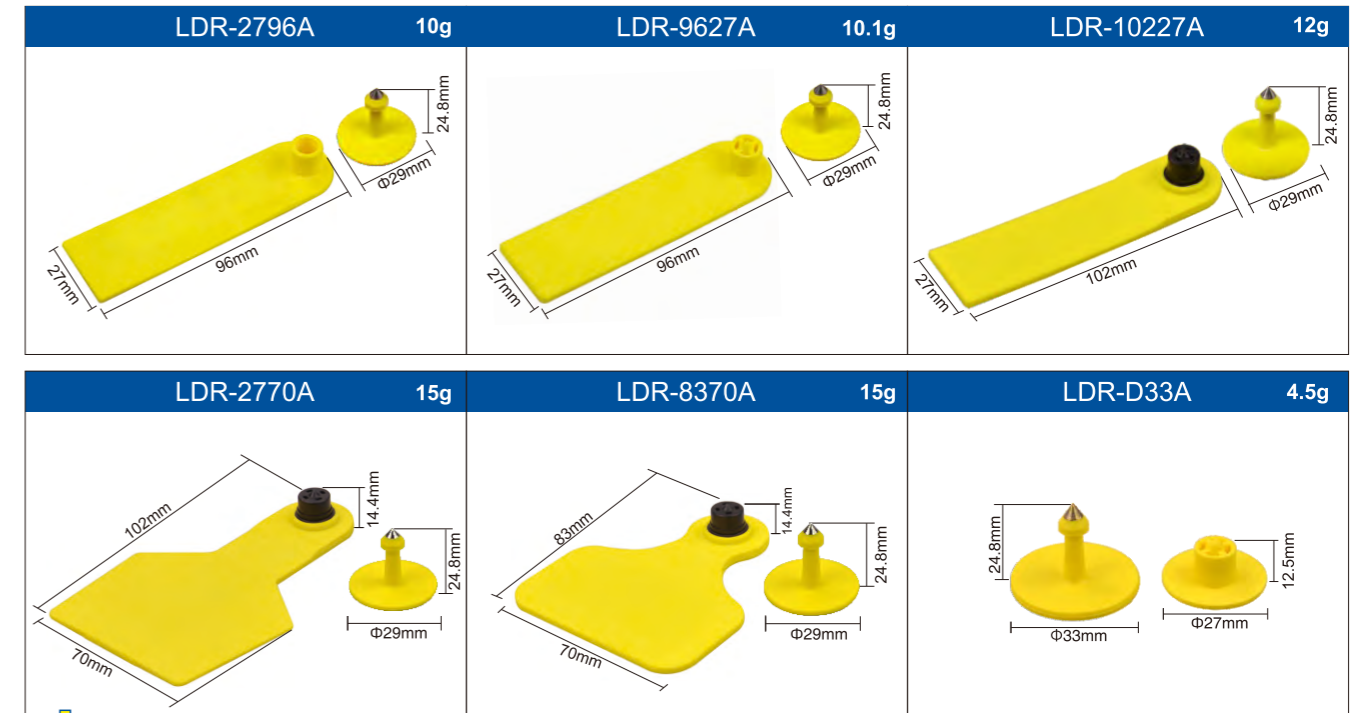

RFID Parameters	
Protocol	ISO/IEC 18000-6C, EPC Class1 Gen2
Frequency	Worldwide 840-960Mhz
Chip	Ucode 8 (Customized)
Memory	EPC128bits、TID48bits、User0bits ( Depend on the chip)
Read&Write	Supported
Read range	1-10meters adjustable(reader and environment dependent)
Data retention	10 years
Write endurance	100000 Cycles
Anti-collision	Support multiple tags reading

Physical Parameters	
Color	Yellow, other color customized
Antenna material	PET+ Aluminum etching
Surface material	TPUAAA
Installation	Ear tag plier
Operating temperature	-10℃ ~ +65℃
Operating humidity	20% ~ 90%RH
Package	Female tag:100pcs/bag, Male tag:100pcs/bag, 1000sets/carton
Customized Service	Laser printing, EPC Pre-written, Color, Chip&Inlay

## LF RFID Animal Ear Tag

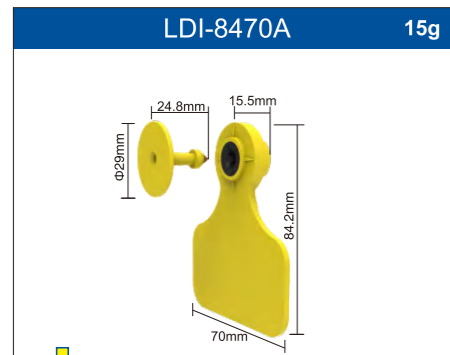

RFID Parameters	
Protocol	ISO/IEC 11784/11785
Frequency	134.2Khz
Chip	HDX / FDX
Read&Write	Supported
Read range	10-30cm adjustable(reader and environment dependent)
Data retention	5-7 years

Physical Parameters	
Color	Green, yellow, other color customized
Antenna material	PET+ Aluminum etching
Surface material	TPUAAA
Installation	Ear tag plier
Operating temperature	-30°C ~ +85°C
Operating humidity	20% ~ 90%RH
Package	Female tag:100pcs/bag, Male tag:100pcs/bag, 1000sets/carton
Customized Service	Laser printing, EPC Pre-written, Color, Chip&Inlay

## Conventional Ear Tag

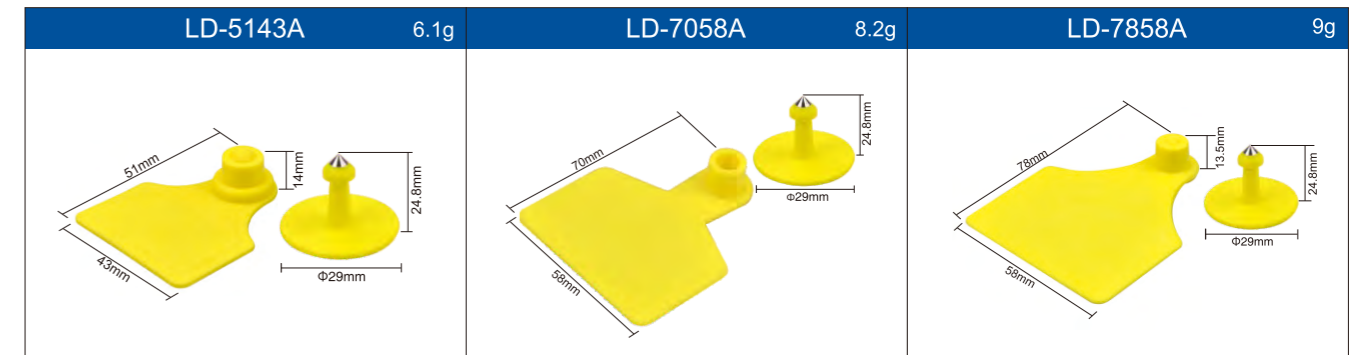

Physical Parameters	
Color	Green, yellow, other color customized
Antenna material	PET+ Aluminum etching
Surface material	TPUAAA
Installation	Ear tag plier
Operating temperature	-20°C ~ +80°C
Operating humidity	20% ~ 90%RH
Package	Female tag:100pcs/bag, Male tag:100pcs/bag, 1000sets/carton
Customized Service	Laser printing, Color,

## UHF RFID Plus LF Animal Ear Tag

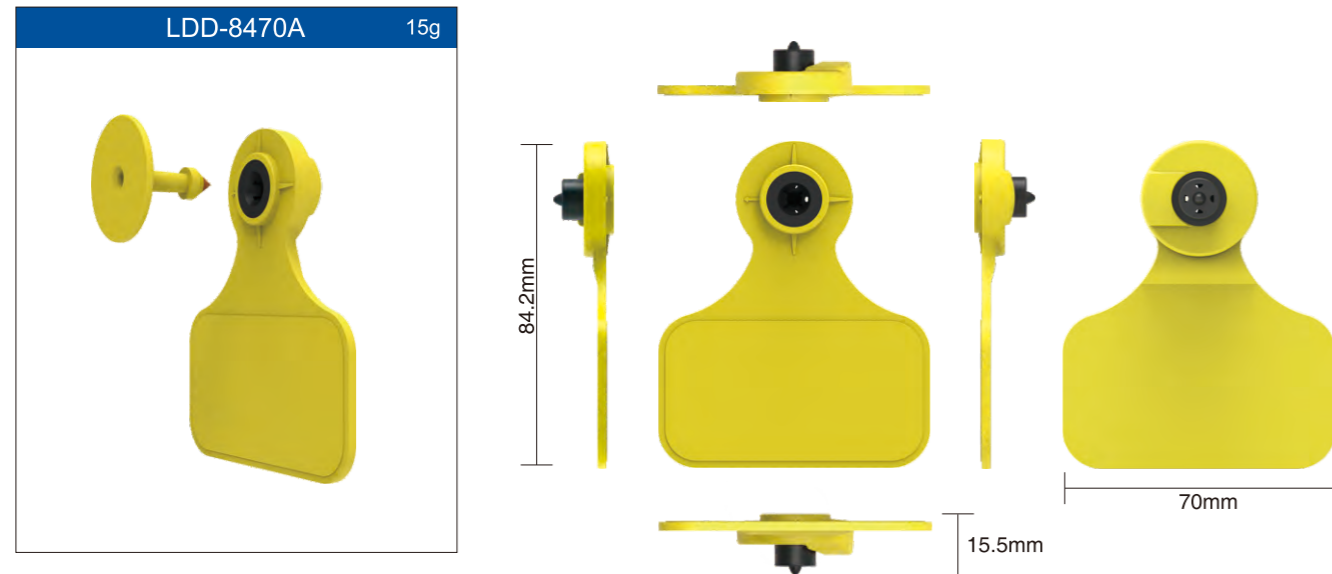

RFID Parameters	
Protocol	ISO11784/11785 + ISO/IEC 18000-6C, EPC Class1 Gen2
Frequency	134.2Khz + Worldwide 840-960Mhz
Chip	HDX/FDX + UHF
Read&Write	Supported
Read range	5-10m adjustabl(Long range fixed reader) 50cm(Handheld reader)
Data retention	10 years
Write endurance	100000 Cycles
Anti-collision	Support multiple tags reading

Physical Parameters	
Color	Green, yellow, other color customized
Antenna material	PET+ Aluminum etching
Surface material	TPUAAA
Installation	Ear tag plier
Operating temperature	-30°C ~ +65°C
Operating humidity	20% ~ 90%RH
Package	Female tag:100pcs/bag, Male tag:100pcs/bag, 1000sets/carton
Customized Service	Laser printing, EPC Pre-written, Color, Chip&Inlay

## Animal Ear Tag Applicator



Physical Parameters	
Size	240x65mm
Weight	340g
Color	Red
Material	Aluminum alloy
Installation	Attach animal ear tags
Suitable	Female ear tag, male ear tag
Package	OPP bag, carton packing

## Stick Reader



Parameters	
Supported parameters	FDX-B, HDX
Response distance	FDX-B:30mm Ear tag ≥ 30cm(±5cm) HDX:30mm Ear tag ≥ 35cm (±5cm)
Protocol	ISO11784/ISO11785
Reading time	Around 100ms
Human machine interaction	LCD liquid crystal screen, buzzer, vibration motor
Power supply	7.4V 1800mAH Lithium battery
Consumption	Read: 3.7W Standby: 0.5W
Capacity	20,000 data for reading; 6,000 data for comparing
Battery life	Can read 10,000 data after fully charged
Communication interface	USB2.0, 4.2 Bluetooth
Size	670x44x41mm

## 134.2khz RFID Glass Tag with Syringe

RFID implantable bio glass tag is a mini electronic device dedicated to animal identification and management, it is an electronic ID for animals that can be automatically identified among with various RFID readers. Thus, it makes such as individual screening, data statistics, whereabouts control, automatic feeding and behavior management etc., many animal research, feeding, management, investigation and other work has realized automation and information technologized, the animal tracking management ability will be greatly improved. Glass tube biological electronic tag is suitable for identification of pet dogs, working dogs and husbandry animal. It is made of biochemical medical grade materials and qualified medical grade production processes, full compliance with ISO 11784/85 international standards, it has been used in large numbers domestically and abroad, and it's all-round management to the whole process of animal growth.

### LDI-SG001



<b>Syringe Size:</b>	50 x 120mm
<b>Package Size:</b>	90 x 220mm
<b>Packing Material:</b>	Medical breathable paper
<b>Disinfection Method:</b>	EO(ethylene oxide)disinfection, valid for five years
<b>Syringe Material:</b>	Polypropylene
<b>Weight:</b>	8.5g
<b>Syringe Color:</b>	Customized

### LDI-G002



2x magnification

<b>Chip:</b>	EM4305
<b>Working Frequency:</b>	134.2 Khz
<b>ISO Standards:</b>	ISO 11784/85 (FDX-B)
<b>Read Range:</b>	7cm(dependent on the environment and readers)
<b>Material:</b>	Glass
<b>Weight:</b>	0.2 gram approx.
<b>Package:</b>	100pcs/pack

### LDI-G003



2x magnification

<b>Chip:</b>	EM4305
<b>Working Frequency:</b>	134.2 Khz
<b>ISO Standards:</b>	ISO 11784/85 (FDX-B)
<b>Read Range:</b>	12cm(dependent on the environment and readers)
<b>Material:</b>	Glass
<b>Weight:</b>	0.3 gram approx.
<b>Package:</b>	100pcs/pack



### Implant location

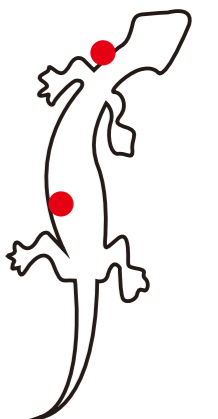
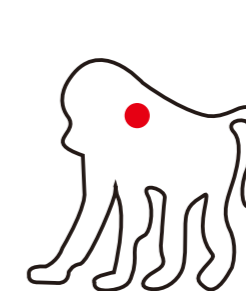
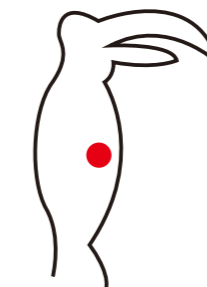
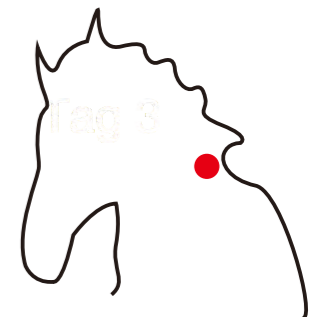
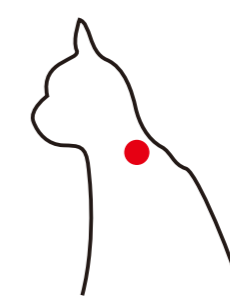

## RFID Label

- 01 UHF RFID Windshield Tag
- 02 UHF RFID Tag
- 03 UHF RFID Jewelry Tag
- 04 UHF RFID Anti-metal Tag
- 05 UHF RFID Clothing Tag
- 06 NFC Sticker
- 07 RFID Library Tag
- 08 RFID Sports Tag
- 09 UHF RFID Special Tag
- 10 Inlay

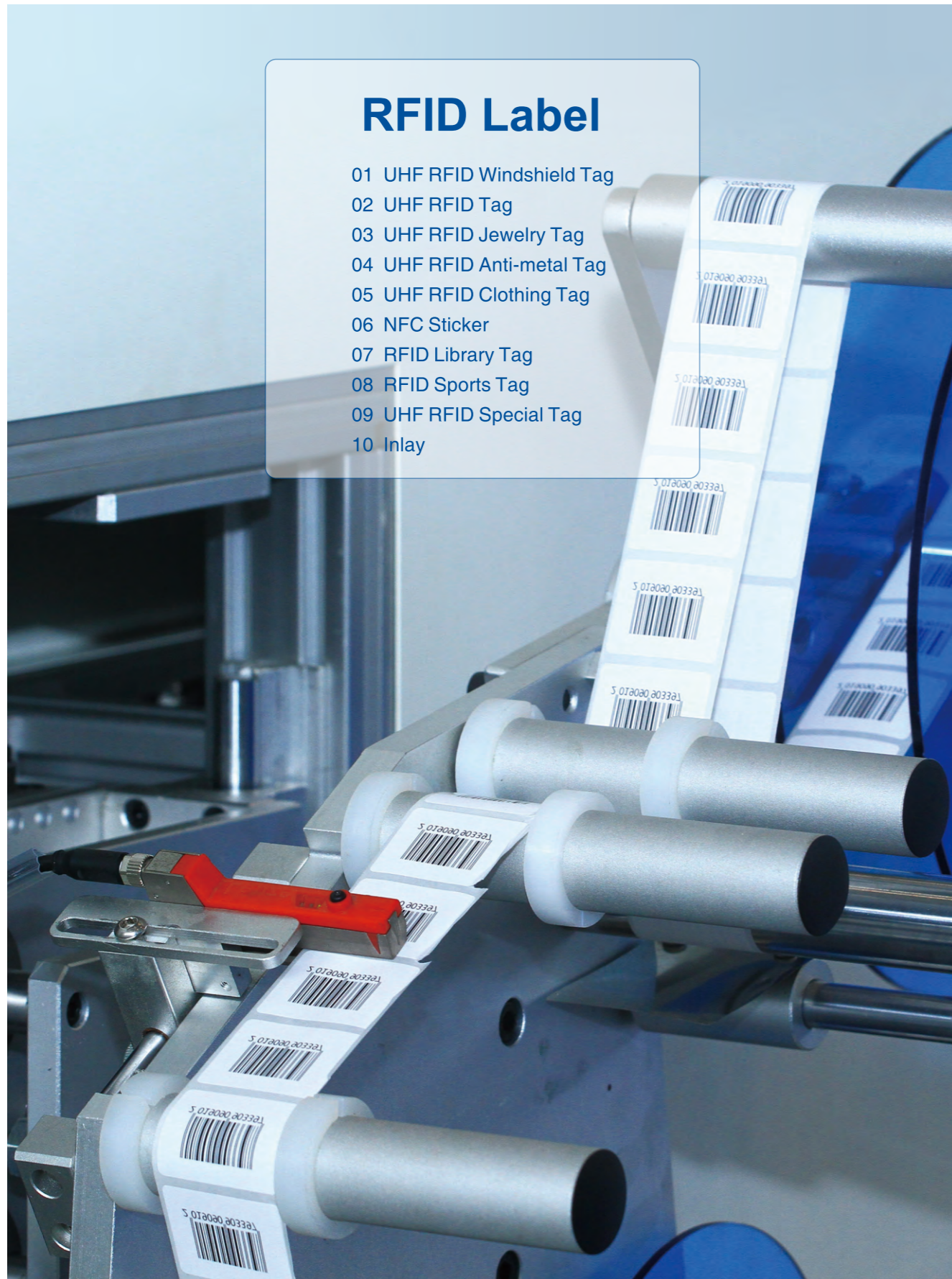

## UHF RFID Windshield Tag



Other sizes can be customized

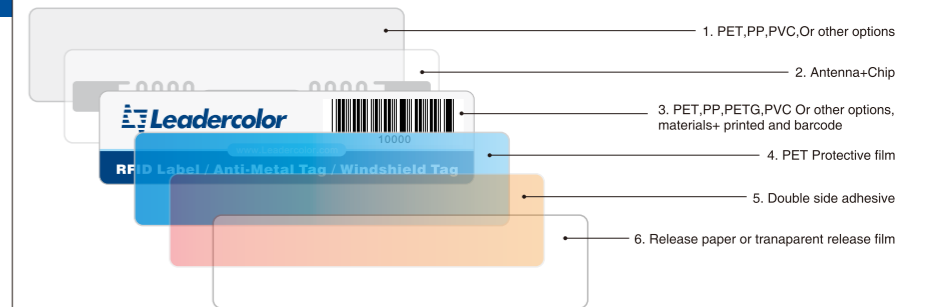

### RFID Parameters

Protocol	ISO/IEC 18000-6C, EPC Class1 Gen2
Frequency	Worldwide 840-960Mhz
Chip	Ucode 8 (Customized)
Memory	EPC128bits、TID48bits、User 0bits (Depend on the chip)
Read&Write	Supported
Read range	1-15meters adjustable (Reader and environment dependent)
Data retention	10 Years
Write endurance	100000 Cycles
Anti-collision	Support multiple tags reading

### Physical Parameters

Substrate material	Transpatent Release Film
Antenna material	Aluminum etching
Surface material	PET Waterproof (Customized)
Encode	Supported
Tamper Proof	Yes
Customized	Chip / Antenna / Material / Glue / Printing / Craft
Package	Roll/Single

## UHF RFID Tag

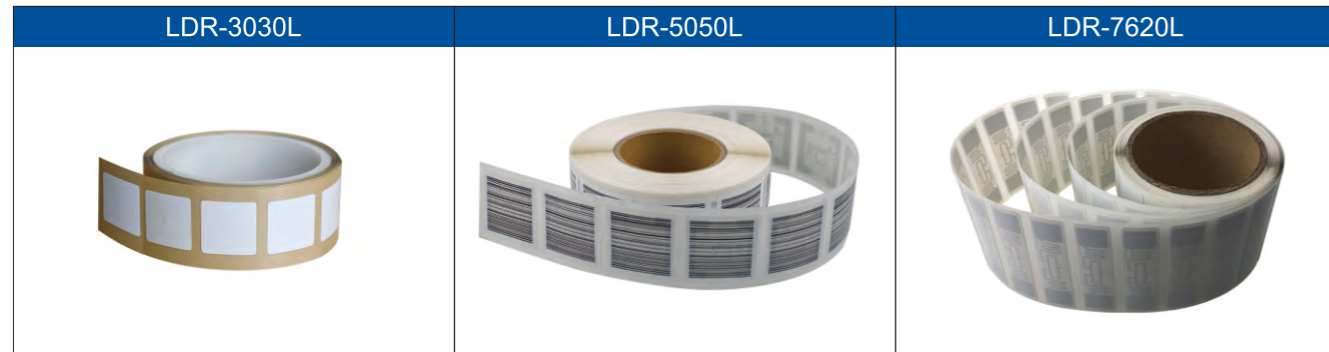

19x68mm	64x25mm
30x30mm	70x20mm
40x25mm	75x75mm
43x18mm	76x20mm
45x30mm	76x50mm
45x45mm	80x60mm
50x23mm	97x27mm
50x50mm	100x35mm
52x30mm	102x25mm
55x30mm	110x45mm
.....	.....
Other sizes can be customized	

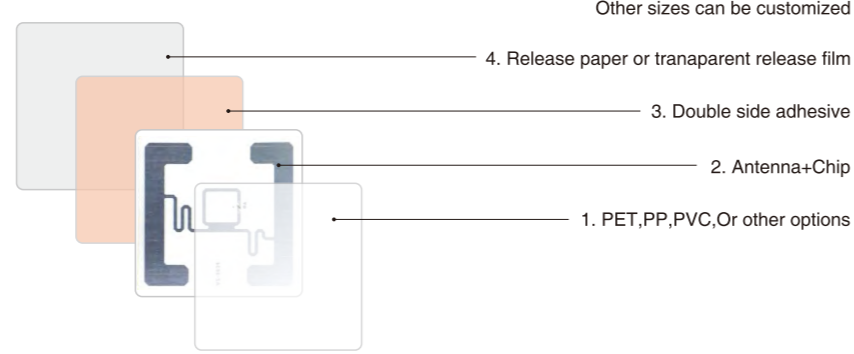

Other sizes can be customized

RFID Parameters	
Protocol	ISO/IEC 18000-6C, EPC Class1 Gen2
Frequency	Worldwide 840-960Mhz
Chip	Ucode 9 (Customized)
Memory	EPC 96bits、TID 48bits、User 0bits (Depend on the chip)
Read&Write	Supported
Read range	1-8meters adjustable (Reader and environment dependent)
Data retention	10 Years
Write endurance	100000 Cycles
Anti-collision	Support multiple tags reading

Physical Parameters	
Substrate material	Release paper
Antenna material	Aluminum etching
Surface material	Coated paper (Customized)
Encode	Yes
Installation	Self adhesive
Customized	Chip / Antenna / Material / Glue / Printing / Craft
Package	Roll/Single

## UHF RFID Jewelry Tag

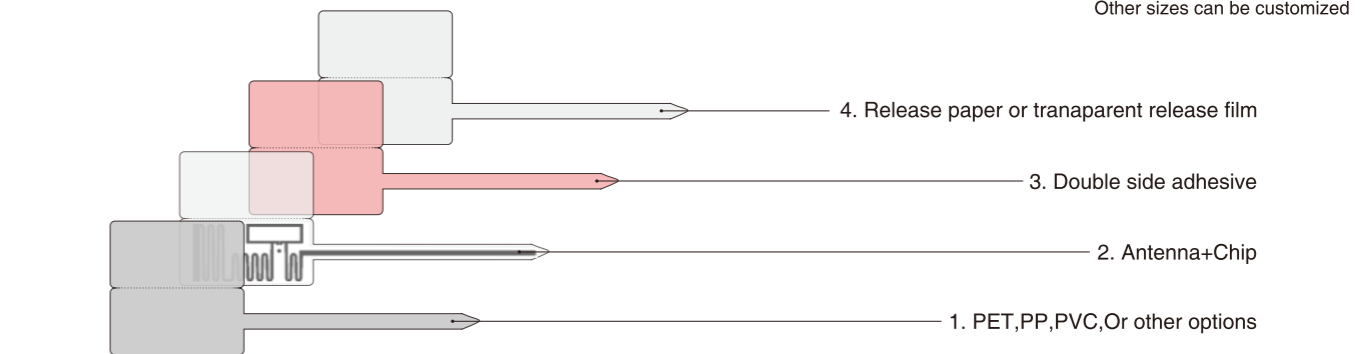

Other sizes can be customized

RFID Parameters	
Protocol	ISO/IEC 18000-6C, EPC Class1 Gen2
Frequency	Worldwide 840-960Mhz
Chip	Ucode 9 (Customized)
Memory	EPC 96bits、TID 48bits、User 0bits (Depend on the chip)
Read&Write	Supported
Read range	1-5meters adjustable (Reader and environment dependent)
Data retention	10 Years
Write endurance	100000 Cycles
Anti-collision	Support multiple tags reading

Physical Parameters	
Substrate material	Release paper
Antenna material	Aluminum etching
Surface material	PET Waterproof (Customized)
Operating temperature	-25°C ~65°C
Operating humidity	20%~90%
Customized	Chip / Antenna / Material / Glue / Printing / Craft
Package	Roll/Single



## UHF RFID Anti-metal Tag

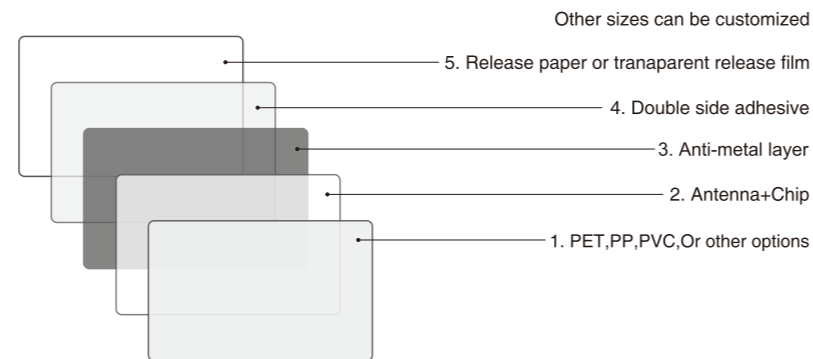

RFID Parameters	
Protocol	ISO/IEC 18000-6C, EPC Class1 Gen2
Frequency	Worldwide 840-960Mhz
Chip	Ucode 8 (Customized)
Memory	EPC 128bits、TID 48bits、User 0bits (Depend on the chip)
Read&Write	Supported
Read range	1-8meters adjustable (Reader and environment dependent)
Data retention	10 Years
Write endurance	100000 Cycles
Anti-collision	Support multiple tags reading

Physical Parameters	
Substrate material	Release paper
Antenna material	Aluminum etching
Surface material	PET paper (Customized)
Encode	Self adhesive
Installation	Yes
Customized	Chip / Antenna / Material / Glue / Printing / Craft
Package	Roll / Single



## UHF RFID Clothing Tag



RFID Parameters	
Protocol	ISO/IEC 18000-6C, EPC Class1 Gen2
Frequency	Worldwide 840-960Mhz
Chip	Ucode 8 (Customized)
Memory	EPC 128bits、TID 48bits、User 0bits (Depend on the chip)
Read&Write	Supported
Read range	1-8meters adjustable (Reader and environment dependent)
Data retention	10 Years
Write endurance	100000 Cycles
Anti-collision	Support multiple tags reading

Physical Parameters	
Material	Textile
Washing cycles	200 Cycles
Heat resistance	-40°C~85°C (-40~185°F)
Installation	Sewing or insert
Washing	100°C (212°F), 60mins,120bar
Tunnel ironing	185°C (365°F), 30mins
Water extractor process	60bar



# NFC Sticker

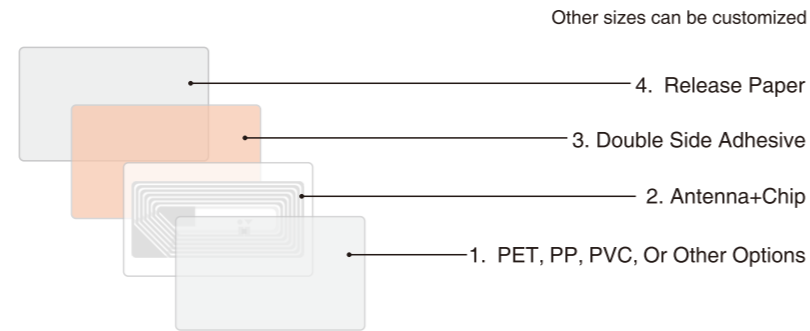

RFID Parameters	
Protocol	ISO/IEC 14443A
Frequency	Worldwide 13.56Mhz
Chip	Ntag213 (Customized)
Memory	UID 7Byte、User 144Byte (Depend on the chip)
Read&Write	Supported
Read range	0.1-10cm adjustable (Reader and environment dependent)
Data retention	10 Years
Write endurance	100000 Cycles

Physical Parameters	
Substrate material	Anti-metal ferrite and transparent release film
Antenna material	Aluminum etching
Surface material	Coated paper (Customized)
Encode	Yes
Installation	Self adhesive
Operating temperature	-25°C ~+65°C
Customized	Chip / Antenna / Material / Glue / Printing / Craft
Package	2000pcs/roll, 3000pcs/roll



## RFID Library Tag



Other sizes can be customized

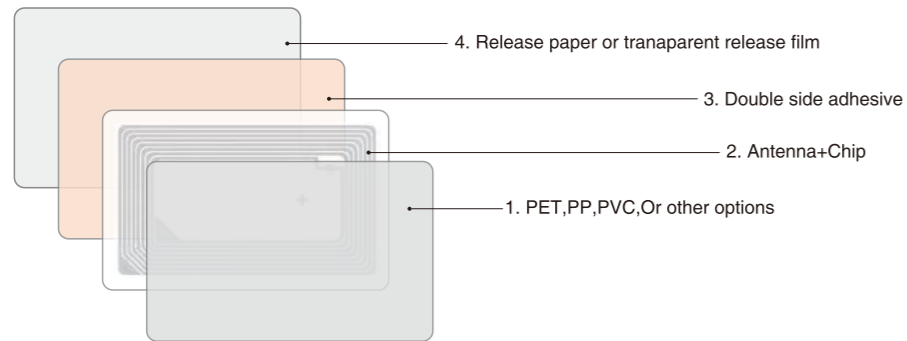

RFID Parameters	
Protocol	ISO/IEC 15693 & 18000-3
Frequency	Worldwide 13.56Mhz
Chip	ICODE@SLIX (Customized)
Memory	UID 8Byte、User 1024Bit (Depend on the chip)
Read&Write	Supported
Read range	0.1-8cm adjustable (Reader and environment dependent)
Data retention	10 Years
Write endurance	100000 Cycles
Anti-collision	Support multiple tags reading

Physical Parameters	
Substrate material	Release paper
Antenna material	Aluminum etching
Surface material	Coated paper (Customized)
Encode	Supported
Installation	Self adhesive
Customized	Chip / Antenna / Material / Glue / Printing / Craft
Package	Roll/Single

## UHF RFID Sport Tag



Other sizes can be customized

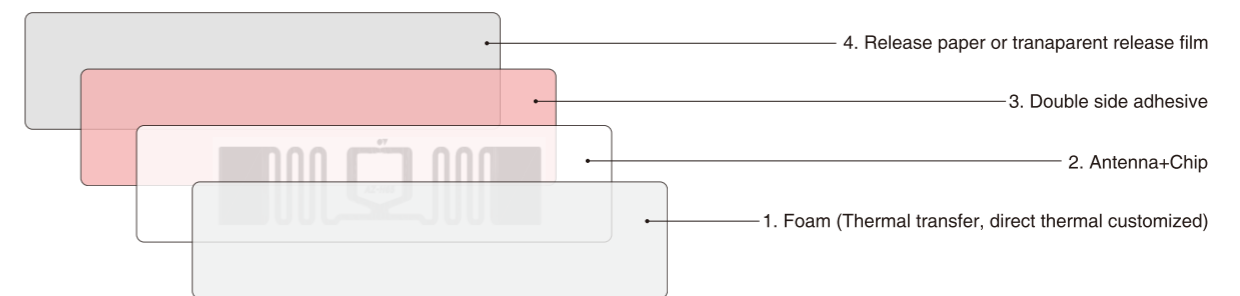

RFID Parameters	
Protocol	ISO/IEC 18000-6C, EPC Class1 Gen2
Frequency	Worldwide 840-960Mhz
Chip	Impinj Monza R6-P (Customized)
Memory	EPC128bits、TID96bits、User 64bits (Depend on the chip)
Read&Write	Supported
Read range	1-7meters adjustable(Reader and environment dependent)
Data retention	10 Years
Write endurance	100000 Cycles
Anti-collision	Support multiple tags reading

Physical Parameters	
Substrate material	Transparent release film
Antenna material	Aluminum etching
Surface material	Foam (Customized)
Operating temperature	-25°C ~65°C
Operating humidity	20%~90%
Customized	Chip / Antenna / Material / Glue / Printing / Craft
Package	Roll/Single

## RFID Special Tag

<p>LDR-4122N</p>  <p>Size: Φ22x41mm</p>	<p>LDR-4128N</p>  <p>Size: Φ28x41mm</p>	<p>LDR-TZ01</p>  <p>Size: 92x28mm, Total length: 448mm</p>
<p>LDR-TZ02</p>  <p>Size: 60x28mm, Total length: 345mm</p>	<p>LDR-TZ03</p>  <p>Size: 78x28x18mm</p>	<p>LDR-TZ04</p>  <p>Size: 28x78mm, Total length: 335mm</p>

RFID Parameters	
Model No.	LDR-4122N
Protocol	ISO/IEC 18000-6C, EPC Class1 Gen2
Frequency	Worldwide 840-960Mhz
Chip	Ucode 8 (Customized)
Memory	EPC 128bits、TID 48bits、User 0bits (Depend on the chip)
Read&Write	Supported
Read range	0-30cm
Data retention	10 Years
Write endurance	100000 Cycles

Physical Parameters	
Anti-collision	Support multiple tags reading
Antenna material	Aluminum etching
Surface material	ABS
Net weight	1.73g
Installation	Inset
Customized	Chip / Antenna / Material / Printing / Craft
Package	Single

## Inlay (Dry inlay+Wet inlay)

<p>LDF-5215</p>  <p>Dry inlay</p>	<p>LDF-D25</p>  <p>Dry inlay</p>	<p>LDF-FD22</p>  <p>Dry inlay</p>
<p>LDF-D25W</p>  <p>Wet inlay</p>	<p>LDR-ALN9654</p>  <p>Wet inlay</p>	<p>LDR-H8</p>  <p>Wet inlay</p>

RFID Parameters		
Protocol	ISO/IEC 14443A	ISO/IEC 18000-6C, EPC Class1 Gen2
Frequency	Worldwide 13.56Mhz	Worldwide 840-960Mhz
Chip	Customized	
Memory	Depend on the chip	
Read&Write	Supported	
Read range	Depends on the antenna, reader, and environment	
Data retention	10 Years	
Write endurance	100000 Cycles	
Anti-collision	Support multiple tags reading	

Physical Parameters	
Substrate material	Transparent release film
Antenna material	Aluminum etching
Surface material	PET Waterproof
Operating temperature	-25℃~65℃
Operating humidity	20%~90%
Customized	Chip / Antenna / Glue / Printing
Package	Roll/Single



## RFID Wristband

- 01 Disposable Wristband
- 02 Silicone Wristband
- 03 Nylon Wristband

## Disposable RFID Wristband

LD-25025B	LDF-25425B(Printable)	LDR-25525B(TYVEK)
		
LDR-35025B	LDR-37025B	Other sizes can be customized
		

RFID Parameters	
Protocol	ISO/IEC 14443A
Frequency	Worldwide 13.56Mhz
Chip	Compatitble MIFARE Classic® 1K (Customized)
Memory	UID 4/7Byte 、 User 1K Byte (Depend on the chip)
Read&Write	Supported
Read range	0.1-10cm adjustable (Reader and environment dependent)
Data retention	10 years
Write endurance	100000 Cycles

Physical Parameters	
Substrate material	Release paper
Antenna material	Aluminum etching
Surface material	PP Waterproof (Customized)
Encode	Supported
Tamper Proof	Supported
Operating temperature	-25°C~+65°C
Customized	Chip / Antenna / Material / Glue / Printing / Craft
Package	Roll/Single

## Silicone RFID Wristband



RFID Parameters	
Model No.	LDF-25535BS
Protocol	ISO/IEC 14443A
Frequency	Worldwide 13.56Mhz
Chip	Compatible MIFARE Classic® 1K (Customized)
Memory	UID 4/7Byte、User 1K Byte (Depend on the chip)
Read&Write	Supported
Read range	1-10cm
Data retention	10 Years
Write endurance	100000 Cycles

Physical Parameters	
Color	Support multiple tags reading
Antenna material	Aluminum etching
Surface material	Silicone Waterproof
Installation	Wrist
Operating temperature	-30°C~+75°C
Customized	Chip / Antenna / Material / Glue / Printing / Craft
Package	100pcs/bag 1000pcs/carton

## Nylon RFID Wristband

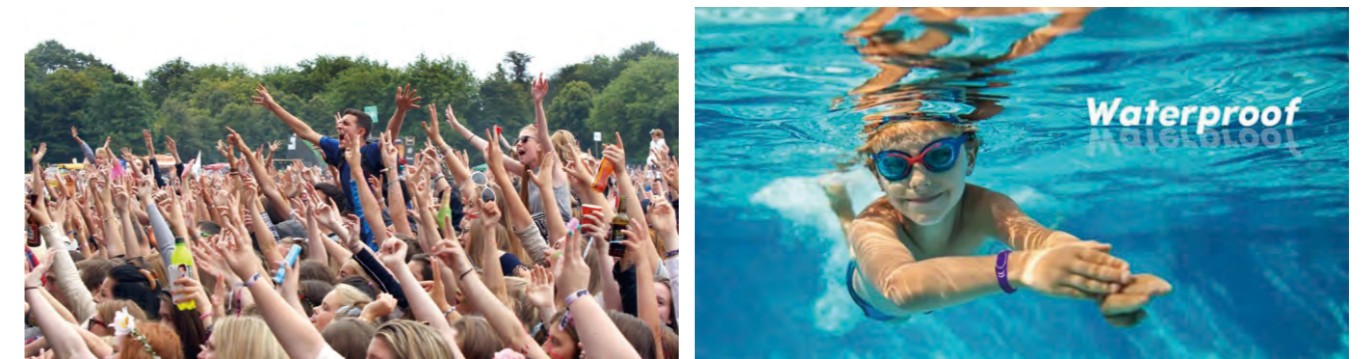

RFID Parameters	
Protocol	ISO/IEC 14443A
Frequency	Worldwide 13.56Mhz
Chip	Compatible MIFARE Classic® 1K (Customized)
Memory	UID 4/7Byte、User 1K (Depend on the chip)
Read&Write	Supported
Read range	1-10cm adjustable (Reader and environment dependent)
Data retention	10 Years
Write endurance	100000 Cycles

Physical Parameters	
Size	350x16mm
Color	Blue/Green/Red/Black/White(or Customized)
Substrate material	Anti-metal ferrite and transparent release film
Antenna material	Aluminum etching
Surface material	Nylon wristband + RFID epoxy card
Encode	Yes
Operating temperature	-30°C~+75°C
Package	100pcs/bag 1000pcs/carton

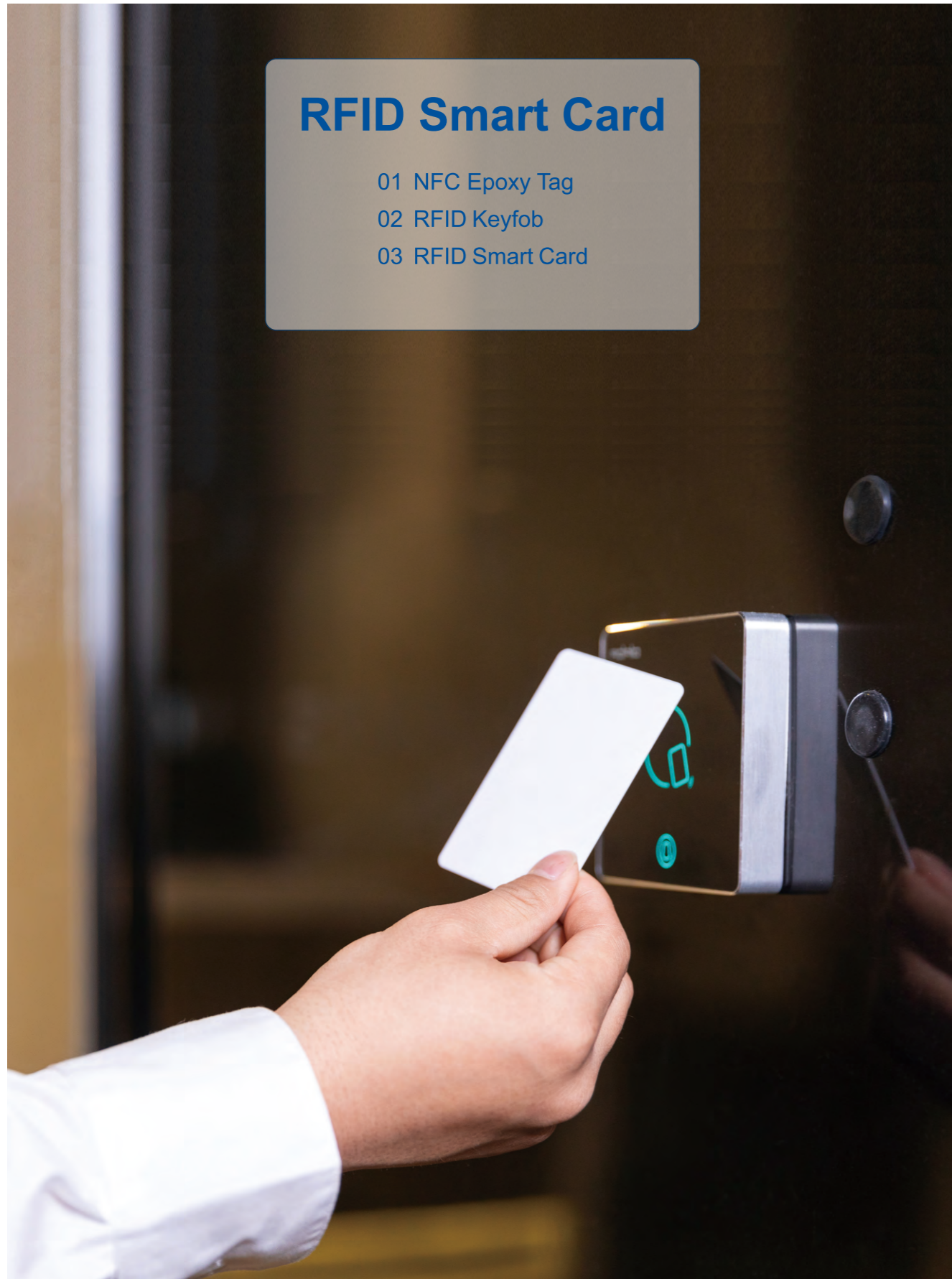

## NFC Epoxy Tag

LDF-4030E	LDF-4525E	LDF-4530E
LDF-D30E / LDF-D40E	LDF-D35EC	LDF-D25EM

RFID Parameters	
Protocol	ISO/IEC 14443A
Frequency	Worldwide 13.56Mhz
Chip	Ntag213 (Customized)
Memory	UID 7Byte 、 User 144Byte (Depend on the chip)
Read&Write	Supported
Read range	0.1-10cm adjustable (Reader and environment dependent)
Data retention	10 Years
Write endurance	100000 Cycles

Physical Parameters	
Size	Customized
Substrate material	Release paper
Antenna material	Aluminum etching
Surface material	PVC + Epoxy
Encode	Supported
Operating temperature	-20℃ ~+80℃
Customized	Chip / Antenna / Material / Printing / Craft
Package	100pcs/bag 1000pcs/carton



## RFID Keyfob

LDF-TK03	LDF-TK04	LDF-TK06
		
LDI-TK02	LDR-TK01	LDR-TK07
		

RFID Parameters	
Protocol	ISO/IEC 14443A
Frequency	Worldwide 13.56Mhz
Chip	Compatible MIFARE Classic®1K (Customized)
Memory	UID 4/7Byte 、 User 1K Byte (Depend on the chip)
Read&Write	Supported
Read range	0.1-10cm adjustable (Reader and environment dependent)
Data retention	10 Years
Write endurance	100000 Cycles

Physical Parameters	
Size	Customized
Color	Black, Blue, Red, Yellow (Customized)
Antenna material	Aluminum etching
Surface material	ABS Waterproof
Encode	Supported
Operating temperature	-20℃~+80℃
Customized	Chip / Antenna / Printing /Color
Package	100pcs/bag 1000pcs/carton

## RFID Smart Card

125Khz	13.56Mhz	860~960Mhz
		
		
		

RFID Parameters	
Protocol	ISO/IEC 14443A
Frequency	Worldwide 13.56Mhz
Chip	Compatible MIFARE Classic®1K (Customized)
Memory	UID 7Byte 、 User 144Byte (Depend on the chip)
Read&Write	Supported
Read range	0.1-10cm adjustable (Reader and environment dependent)
Data retention	10 Years
Write endurance	100000 Cycles

Physical Parameters	
Size	86x54x0.84mm (Customized)
Material	PVC Plastic
Antenna material	Aluminum etching
Surface material	Matt or glossy
Encode	Supported
Operating temperature	-10℃~+50℃
Customized	Chip / Antenna / Material / Printing /Color
Package	200pcs/box,10boxes/carton



## RFID Reader

- 01 UHF RFID Reader
- 02 HF RFID Reader
- 03 LF RFID Reader
- 04 UHF RFID Antenna
- 05 UHF RFID Module

## UHF RFID Reader

<p><b>LDR-RD01</b></p> <p>Size: 105x70x11mm</p>	<p><b>LDR-RD02</b></p> <p>Size: 160x110x40mm</p>	<p><b>LDR-RD04</b></p> <p>Size: 160x110x40mm</p>
<p><b>LDR-RI01(US)</b></p> <p>Size: 235x235x57mm</p>	<p><b>LDR-RI01W(US)</b></p> <p>Size: 235x235x57mm</p>	<p><b>LDR-RI01RJ(US)</b></p> <p>Size: 235x235x57mm</p>
<p><b>LDR-RI01(EU)</b></p> <p>Size: 260x260x45mm</p>	<p><b>LDR-RI01W(EU)</b></p> <p>Size: 260x260x45mm</p>	<p><b>LDR-RI01RJ(EU)</b></p> <p>Size: 260x260x45mm</p>
<p><b>LDR-RI02(US/EU)</b></p> <p>Size: 445x445x55mm</p>	<p><b>LDR-RI02W(US/EU)</b></p> <p>Size: 445x445x55mm</p>	<p><b>LDR-RI02RJ(US/EU)</b></p> <p>Size: 445x445x55mm</p>
<p><b>LDR-U72S</b></p> <p>Size: 178x83x17mm</p>	<p><b>LDR-G02</b></p> <p>Size: 1590x400x50mm</p>	<p>Please refer to the specification for the detailed parameters of the product</p>

## HF RFID Reader

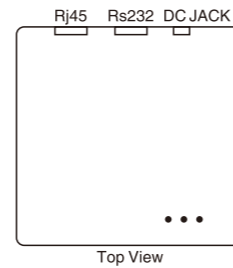
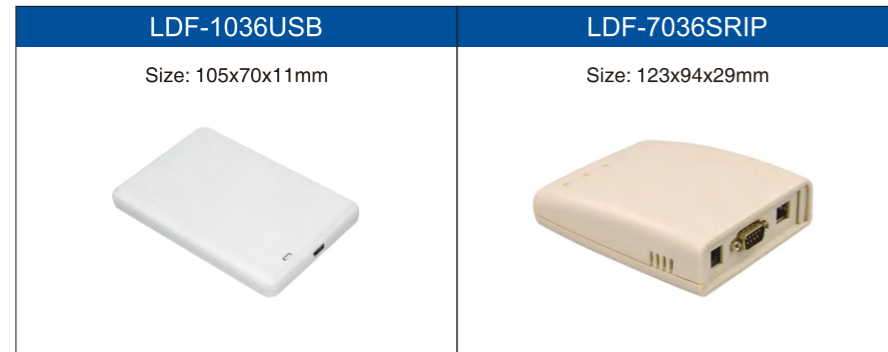

### PRODUCT FEATURES (LDF-7036SRIP)

1. Support mainstream ISO/IEC15693, ISO14443TypeA/TypeB protocol tag (TI, PHILIPS, ST, INFINEON, FUJITSU, EM...);
2. Advanced tag processing algorithm,high identification rate;
3. Built-in TX/RX antenna with effective distance up to 100mm\*;
4. Support Transparent Command operation ;
5. Low power dissipation design with single DC+12V power source needed;
6. Support TCP/IP and RS232 interface and provide DLL and demonstration software to facilitate development;
7. Provide DLL and demonstration software to facilitate development.

### CHARACTERISTICS

Absolute Maximum Rating

ITEM	SYMBOL	VALUE	UNIT
Power Supply	VCC	12	V
Operating Temp.	T <sub>OPR</sub>	-10~+60	°C
Storage Temp.	T <sub>STR</sub>	-25~+80	°C

Electrical and Mechanical Specification

Under TA=25°C, VCC=+12V unless specified

ITEM	SYMBOL	VALUE	UNIT
Power Supply	VCC	12	V
Operating Temp.	T <sub>OPR</sub>	-10~+60	°C
Storage Temp.	T <sub>STR</sub>	-25~+80	°C
Storage Temp.	T <sub>STR</sub>	-25~+80	°C

\*Effective distance depends on tag and working environment

Remark:

1. Specifications are subject to change, please pay attention to our latest one.
2. Leadercolor reserves the right to the final interpretation of the above terms.

## LF RFID Reader



### INTRODUCTION

This is Long-distance ISO11784/11785 reader, This reader supporting animal ear tags using the reading distance is 45cm±10%.

### PRODUCT FEATURES (LDI-A04)

1. Support read operations on the Em4305, S256, T5577 according to ISO11784/ISO11785;
2. Support ISO11784/5 Standard;
3. Size: 260mm x 260mm x 35mm;
4. Operating voltage: 15V-DC, operating current: <150mA;
5. UART, Rs232, RS485 Multiple interfaces can be options;
6. Long-distance: Read LF Animal tag more than 40cm;
7. High stability: can automatically adapt to the environment;
8. High reliability: ESD protection, anti-surge protection;
9. Application area: pig management, cattle management, sheep management, parking management.

## UHF RFID Antenna



**Application:**

1. Intelligent traffic management;
2. Logistics such as container management;
3. Ticketing, school attendance, asset tracking;
4. Access control, automatic weighing;
5. Animal tracking.

RFID Parameters	
Model No.	LDR-UA01
Frequency	Worldwide 840-960Mhz
Antenna Type	8dbi circularly polarized Auto-gaining antenna
Connector Type	N-female, others optional
Working Mode	Need to work with RFID reader hub
Read&Write Range	1-6m adjustable (Tag and environment dependent)
Anti-collision	Support multiple tags reading

Physical Parameters	
Size	260x260x45mm
Material	ABS Waterproof
Mounting	Pole/Ceiling
Operating temperature	-10°C~+60°C
Protection level	Outdoor IP54
Package	100pcs/ bag
Max input power	100W
Lightning protection	DC ground
Accessories	1xBracket, 1xConnection cable
Package	1unit/carton

## UHF RFID Module



RFID Parameters			
Item No.	MCR-600	MCR-800	MCR-900
RF Channel	Single channel	Four channel	Eight channel
Connector	MMCX	SMA	SMA
Antenna connection mode	Single antenna	Four antenna	Eight antenna
Interface connector	Molex 53261-1571		
RF connectionmaterial	Gold-plated brass		
PCB material	Rogers FR4 gold-plated		
Shield material	Aluminum		

Physical Parameters	
Operating voltage	3.7V-5V
Standby mode current	<50mA (EN high level)
Sleep mode current	<100mA (EN low level)
Operating temperature	-10°C ~ +50°C
Output power	0 – 33dBm
Receive sensitivity	< -85 dBm
Peak inventory speed	> 700 tags/sec
Label buffer	1000tags@96 bit EPC
Tag RSSI	Supported
Antenna detector	Supported
Ambient temp monitor	Supported
Working mode	Single/DRM
Host communication	TTL Uart port
GPIO	2inputs optical coupling, 2outputs optical coupling
Max baud rate	115200 bps
Heat dissipation	External cooling fin