

SPECIFICATION

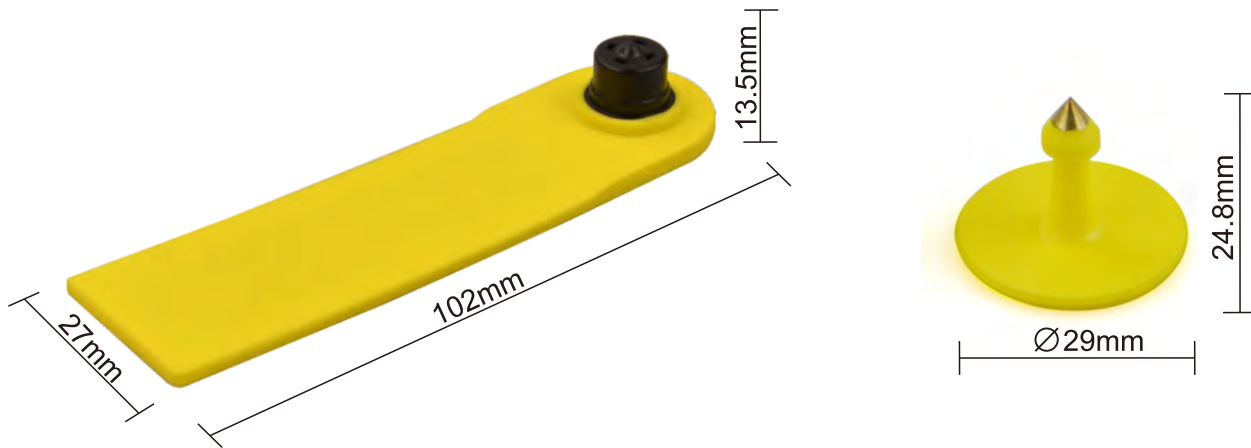

Product Name: RFID Animal Ear Tag

Item No.: LDR-10227A



Quick Details

LDR-10227A UHF RFID Strip Ear Tag characters in long reading range up to 10meters and flexible good quality material. It is designed for livestock management which is effective to keep tracking of livestock, such as cows, sheeps and deers. It helps ranchers to manage their sheeps easily and time-saving, not only on counting sheep numbers, but also record their vaccine, growth, weight and so on.

RFID Parameter

Model No.	LDR-10227A
Type	Passive UHF RFID Animal Tag
Protocol	ISO/IEC 18000-6C, EPC Class1 Gen2
Frequency	Worldwide 840-960Mhz
Chip	Ucode 8
Memory	EPC 128bits/ TID 96bits / User 0bits
Read&Write	Supported
Data retention	10years
Read Range	1-10m adjustable(reader and environment dependent)
Programming Cycles	100,000 cycles
Anti-collision	Support multiple tags reading

Physical Parameter

Size	Female tag: 102×27×14.5mm, Male tag: Φ29×24.8mm
Color	Yellow, other color customized
Antenna Material	PET+ Aluminum Etching
Surface Material	TPU AAA
Installation	Ear Tag Plier
Operating Temperature	-20℃ ~ +80℃
Operating Humidity	20% ~ 90%RH
Package	Female tag: 100pcs/bag, Male tag: 100pcs/bag, 1000sets/carton
Customized Service	Laser Printing / Color / Chip / Antenna / EPC Pre-written

Picture

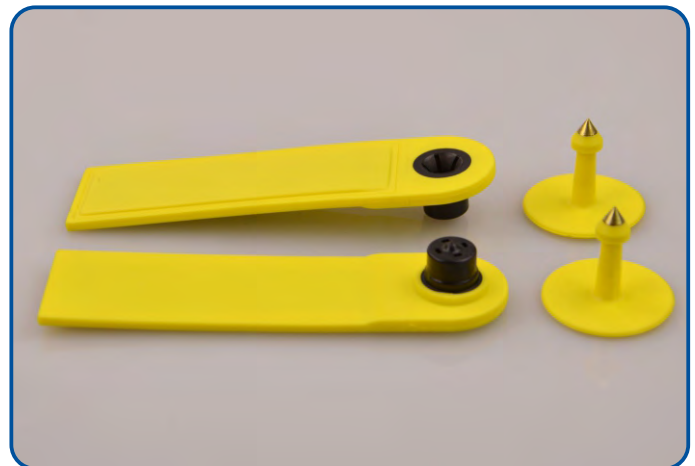
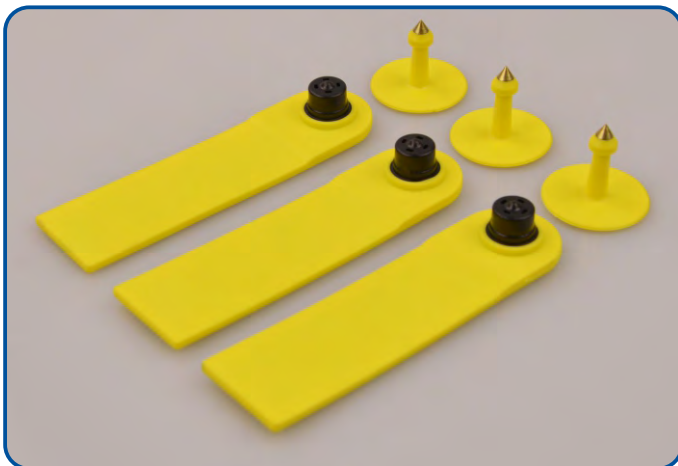
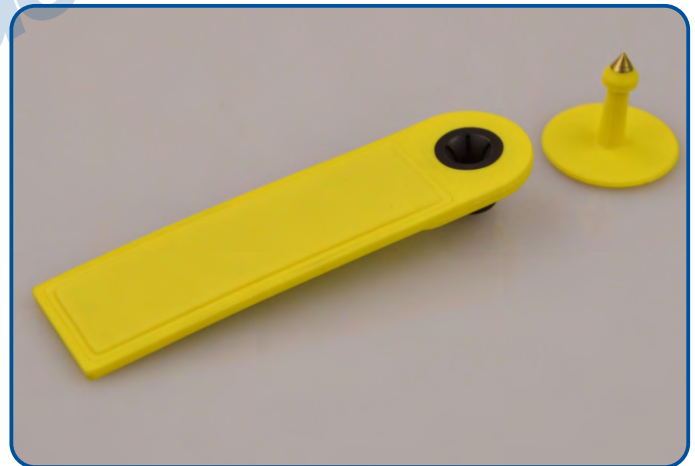
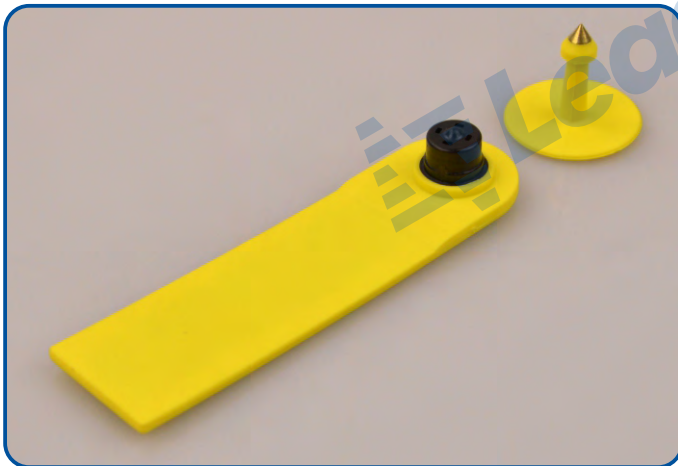

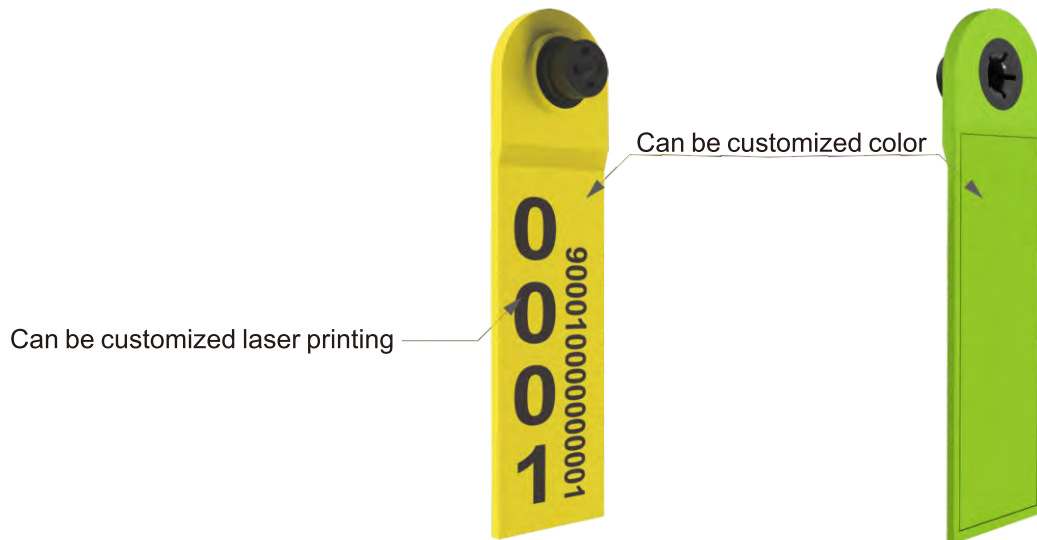

Size

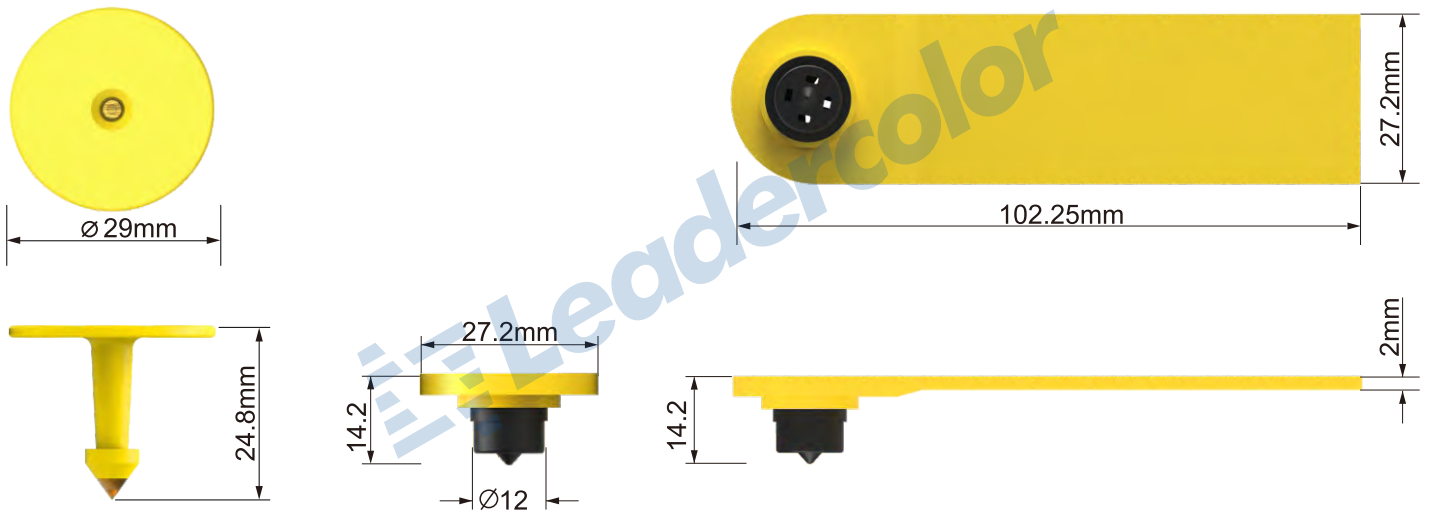

Installation



 Application

- Livestock animal identification
- Sheep, pigs and dog's tracking
- Intelligent cow management

